





713 series – Field wireable M12 connectors with stainless steel locking ring



- wrench size of the M12 locking ring was changed from SW19 to SW18.
- Therefore the torque spanner with part No. 07-0079-000 can be used
- Easier handling in areas with limited space with a pre-defined torque
- new and old versions cost the same
- available from October 2008 on.



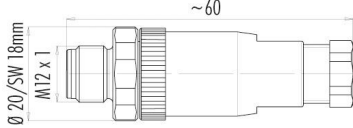

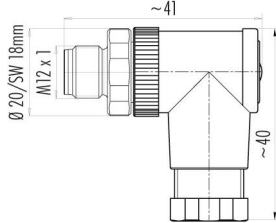
713 series – Field wireable M12 connectors with stainless steel locking ring

Description/ Picture	Dimensional drawing	Contacts	Cable outlet (in mm)	Order No.
<p>Male cable connector, stainless steel locking ring, gold plated contacts, screw termination</p> 		<p>4</p> <p>5</p> <p>8</p>	<p>4-6 6-8</p> <p>4-6 6-8</p> <p>6-8</p>	<p>99-0429-82-04 99-0429-282-04</p> <p>99-0437-82-05 99-0437-282-05</p> <p>99-0487-282-08</p>
<p>Angled male cable connector, stainless steel locking ring, gold plated contacts, screw termination</p> 		<p>4</p> <p>5</p>	<p>4-6 6-8</p> <p>4-6 6-8</p>	<p>99-0429-92-04 99-0429-292-04</p> <p>99-0437-92-05 99-0437-292-05</p>



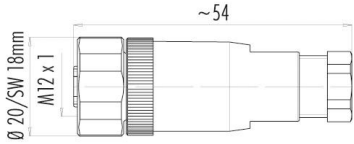

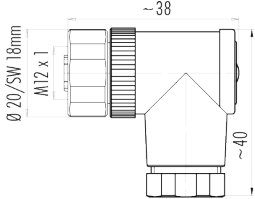
713 series – Field wireable M12 connectors with stainless steel locking ring

Description/ Picture	Dimensional drawing	Contacts	Cable outlet (in mm)	Order No.
<p>Female cable connector. Stainless steel locking ring, gold plated contacts, screw termination</p> 		<p>4</p> <p>5</p> <p>8</p>	<p>4-6 6-8</p> <p>4-6 6-8</p> <p>6-8</p>	<p>99-0430-82-04 99-0430-282-04</p> <p>99-0436-82-05 99-0436-282-05</p> <p>99-0486-282-08</p>
<p>Female cable connector, stainless steel locking ring, gold plated contacts, screw termination</p> 		<p>4</p> <p>5</p>	<p>4-6 6-8</p> <p>4-6 6-8</p>	<p>99-0430-92-04 99-0430-292-04</p> <p>99-0436-92-05 99-0436-292-05</p>

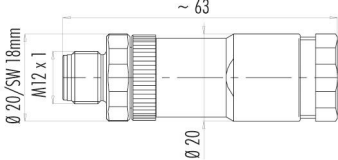

713 series – Field wireable M12 connectors with stainless steel locking ring

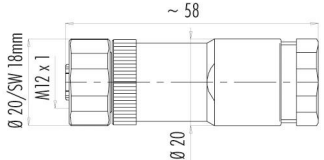
Description/ Picture	Dimensional drawing	Contacts	Cable outlet (in mm)	Order No.
<p>Male dual way connector, stainless steel locking ring, gold plated contacts, screw termination</p> 		<p>4</p> <p>5</p> <p>8</p>	<p>2 Kabel Ø 2,1 – 3 mm oder Ø 4-5 mm</p>	<p>99-0429-287-04</p> <p>99-0437-287-05</p> <p>99-0487-287-08</p>
<p>Female dual way connector, stainless steel locking ring, gold plated contacts, screw termination</p> 		<p>4</p> <p>5</p> <p>8</p>	<p>2 cable Ø 2,1 – 3 mm or Ø 4-5 mm</p>	<p>99-0430-287-04</p> <p>99-0436-287-05</p> <p>99-0486-287-08</p>

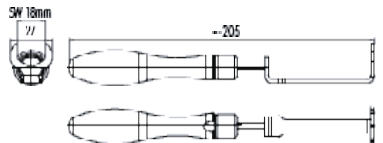

713 series – Field wireable M12 connectors with stainless steel locking ring

Description/ Picture	Dimensional drawing	Cable outlet (in mm)	Order No.
<p>Torque spanner with limited torque for 713 series</p> <p>Schlüssel mit Drehmomentbegrenzung Sechskant für Serie 713 Hexagon torque spanner for 713 series</p> 		<p>2 cable Ø 2,1 – 3 mm or Ø 4-5 mm</p>	<p>07-0079-000</p>